

Pos.	Qty.	Art. No.	Description	Pos.	Qty.	Art. No.	Description
1	1	9384-48	Power switch with LED	12	1	9327-84	Cover
2	1	9310-13	Scale 7 kp, complete	13	1	9301-145	Support tube rear, complete
	1	9310-152	-Scale		2	9309-51	-Plastic cap
	1	9000-103	-Pole screw M5x12, white		2	9328-26	-Rubber foot with screw M8
3	1	9310-620	Side cover, right	14	1	9329-3	Seat for recumbent, complete
4	1	8243-7	Holder for cable	15	1	9308-133	-Locking knob
5	1	9310-71	Lock to front cover	16	1	9311-125	Swivel module
6	1	9310-20	Front cover	17	1	9326-97	Lever for length adjustment
7	1	9310-630-1	Side cover, left	18	2	9311-142	Stop
8	1	9301-4	Support tube front, complete	19	1	74435-1	Pedals for recumbent, pair
	2	9328-51	-Plastic cap	20	1	9311-36	Side cover rear, right
	2	9328-26	-Rubber foot with screw M8	21	1	9311-86	Handlebar for recumbent, complete
	2	9000-38	-Transport wheel, complete	22	2	9312-12	Knurled screws
9	1	9310-605	Side cover rear, left	23	1	9312-4	Monark novo Display Unit
10	1	9000-103	-Pole screw M5x12, white		1	9000-211	Calibration weight 4 kg
11	1	9328-26	Rubber foot with screw M8		1	9312-31	Chest belt Polar H7

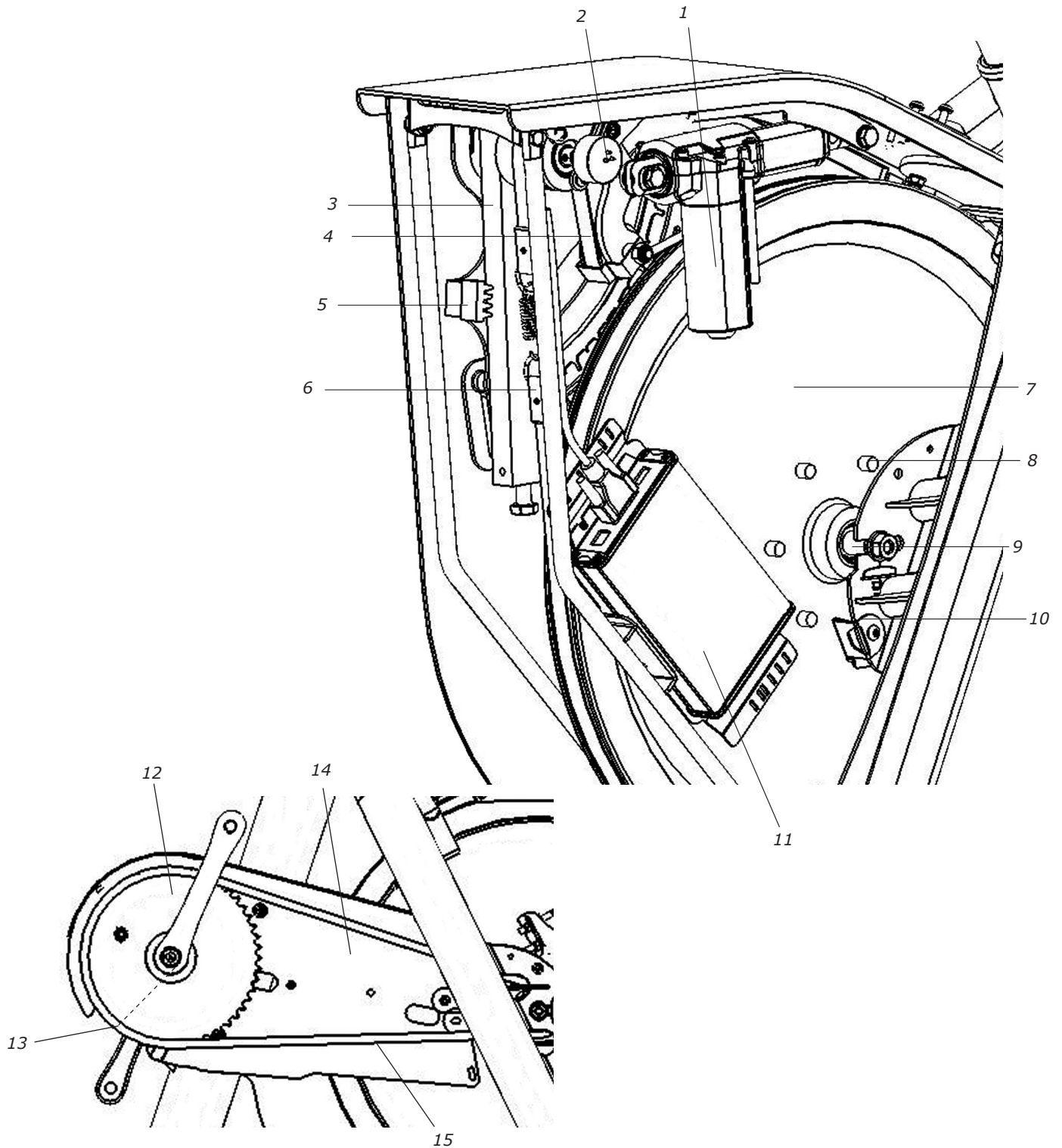

Pos.	Qty.	Art. No.	Description	Pos.	Qty.	Art. No.	Description
1	1	9310-56	Motor package, complete	7	1	9300-31	Flywheel, complete with magnets
	1	9310-55	-Motor	8	6	9374-16	-Magnets
2	1	9311-67	Potentiometer with cable	9	1	9300-24	-Flywheel suspension, complete
3	1	9310-45	Pendulum 7 kp, complete	10	1	9311-84	Sensor with bracket, complete
	1	9310-43	-Pointer	11	1	9311-906	Monark novo control unit RC6
	1	9326-88	-Spring	12	1	9300-430	Crank set, steel, 52T, 170 mm
4	1	9100-26	Tension cylinder	13	1	9300-340	Cartridge bottom bracket 68/122 mm
5	2	9300-99	Stop	14	1	9311-6	Chain guard
6	1	9310-94	Brake belt, complete	15	1	9310-118	Chain 9300, 120 L, with chain lock
	1	9311-9312	Power cord for power adaptor, EU	1	1	9311-9311-1	Power adaptor